

UPRIGHT REACH-IN FREEZERS

Top Mounted Condensing Unit

ES – Series • ESF1 • ESFH2 • ESF2 • ESWF2 • ESF3



▲ ESF1



▲ ESFH2



▲ ESF2



▲ ESWF2



▲ ESF3

Cabinet Construction

Heavy duty stainless steel interior and exterior, with galvanized steel finished top, bottom and back wall of exterior. ABS evaporator drain covers. 2.5" thick high density foamed-in-place polyurethane insulation. Four 4" diameter casters (front casters with brakes). Door heater installed around inside cabinet frame to prevent moisture build-up.

Refrigeration System

- Self-contained condensing unit located at top of cabinet for high performance
- Oversized condenser and evaporator coils quickly achieve and maintain desired temperature
- Forced-air cooling with multiple evaporator fan motors provide balanced airflow throughout cabinet to ensure faster temperature drop
- Environmentally friendly CFC free R-134A and R-404A refrigerant
- Adjustable, time-initiated defrost cycle of 3 to 12 hours with 350 watt defrost heater, both time and temperature terminated for fail-safe operation
- Automatic evaporator fan motor delay after defrost cycle
- Copper tube and aluminum fin evaporator with anti-corrosive coating
- Exterior anodized aluminum drain pan for self sufficient condensation removal
- Pressure relief ports for rapid re-entry
- Interior airflow backward to ensure proper air circulation
- Pre-wired and ready to plug, 115V/60Hz/1Ph, (NEMA 5-15P for models ESF1, ESFH2), (NEMA 5-20P for models ESF2, ESWF2, ESF3)

Lighting

- Shielded incandescent interior lighting

Doors

- Heavy duty stainless steel interior and exterior
- 2.5" thick high density foamed-in-place polyurethane insulation
- Rounded corners for a comfortable and hazard-free work space
- Heavy duty adjustable torsion spring self-closing door system
- One piece snap-in magnetic door gaskets for easy replacement
- Heavy duty recessed door handles for a flat surface
- Door locks
- Field reversible doors

Shelving

- Three epoxy coated wire shelves per section
- Stainless steel pilasters and shelf clips

Temperature Control

- Factory preset temperature, -4°F
- Temperature setting range from -10°F to 54°F
- Easy to read digital temperature display
- Easy to program push-button temperature control
- Microchip digital control and monitoring system with a variety of functions to monitor and maintain optimum temperature



5 YEAR Compressor
3 YEAR Parts & Labor

Dimensions

ABS Legs



Two additional front adjustable stainless steel clad ABS legs for model ESF1 and ESFH2 to provide extra stability when opening and closing doors, and one additional leg for ESF3 for weight support.



Equipped with 9tf long NEMA 5-15P plug. (model ESF1, ESFH2)



Equipped with a 9tf long NEMA 5-20P plug. (model ESF2, ESWF2, ESF3)

Side View

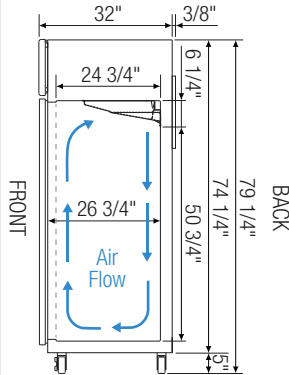

ESF1, ESFH2, ESF2, ESWF2

Side View

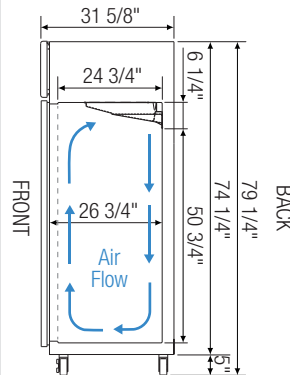

ESF3

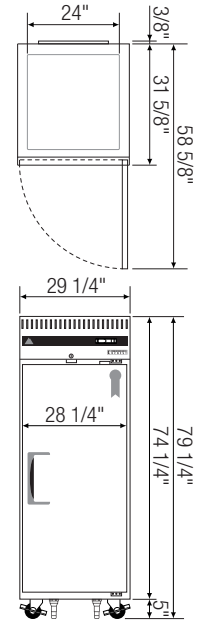

▲ ESF1

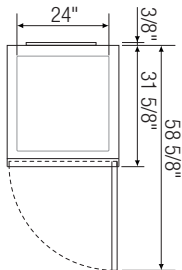

▲ ESFH2

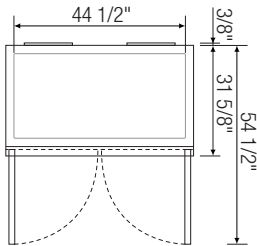

▲ ESF2

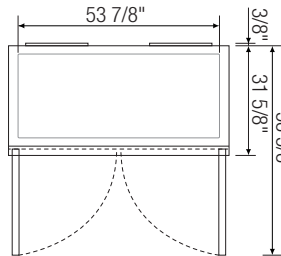

▲ ESWF2

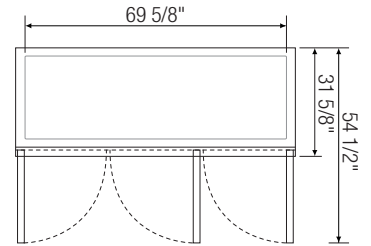

▲ ESF3

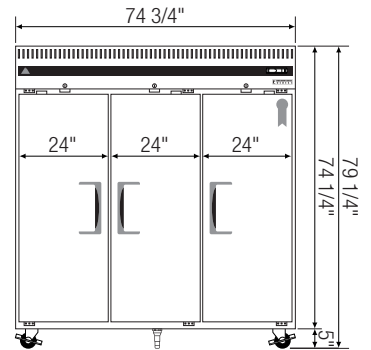
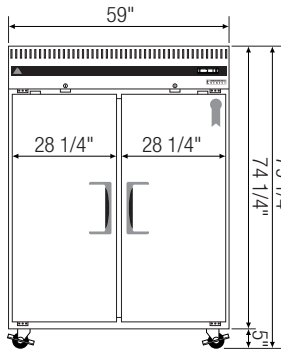
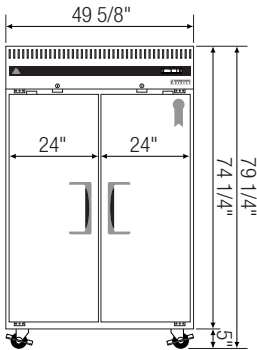
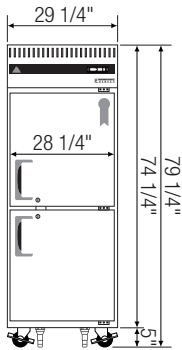

Model	Ref/ Frz/ Dual	# of Doors	Capacity (Cu.Ft.)	HP	BTU/HR †	Refrigerant	# of Shelves	Power (V-Hz-Ph)	Amps	Crated Weight (LBS)	Exterior Dimensions (Inches)		
											L	D	H *
ESF1	Frz	1	23	1/2	3,435	R-404A	3	115-60-1	7.57	300	29 1/4	32	74 1/4
ESFH2	Frz	2 (H)	23	1/2	3,435	R-404A	3	115-60-1	7.57	302	29 1/4	32	74 1/4
ESF2	Frz	2	48	1/2 x 2	3,435 x 2	R-404A	6	115-60-1	14.81	468	49 5/8	32	74 1/4
ESWF2	Frz	2	55	1/2 x 2	3,435 x 2	R-404A	6	115-60-1	14.81	507	59	32	74 1/4
ESF3	Frz	3	71	1/2 x 2	3,435 x 2	R-404A	9	115-60-1	14.81	TBA	74 3/4	31 5/8	74 1/4

* : Height does not include 5" for casters.

† : Based on evaporating temperature of 14°F (-10°C) & condensing temperature of 131°F (55°C).

Frz = Freezer | (H) = Half Door

Specifications subject to change without notice.

Product dimensions are for general purposes and not absolute value. Product capacity(▶) is calculated based on standard industry figures. Slight variations may exist. If dimensions and capacity are critical, please contact Everest Refrigeration.



Only units certified by NSF :
**ESF1, ESF2,
ESWF2, ESF3**



Please visit our website for updated Energy Efficiency information.